



Static and Mobile Desk Systems

2018
Specification Guide



TABLE OF CONTENTS

Ordering Information	3
Stationary Reference Desks	7
Stationary Reference Desk Sample Configurations	16
Mobile Reference Desks	22
Mobile Reference Desk Sample Configurations	29
Media Tables	37
Desk Measurements	38



ORDERING INFORMATION

How To Order

Orders may be placed by authorized Demco representatives or dealers. Verbal orders are not accepted.

Mail: Demco
4810 Forest Run Road
Madison, WI 53704

Fax purchase orders to: 800.730.8094

For Customer Service call: 800.747.7561

All orders must show quantity, catalog number, description, colors and customer purchase order number. Demco does not assume responsibility for errors on orders not submitted in writing.

Acknowledgment

Demco will issue a written Order Acknowledgment for each order accepted. Estimated ship dates are stated on Acknowledgments. All orders are considered correct as acknowledged. **Order changes may affect the estimated ship date. Customers must review acknowledgments promptly and notify Demco of any error.** Customer will receive a shop drawing of their TechnoLink order prior to production that MUST be approved by the customer in order to proceed.

Pricing

All prices are list and FOB factory. This catalog supersedes all prices previously quoted and is subject to change. Possession of this price list does not constitute an offer to sell.



ORDERING INFORMATION

Standard Finishes

All catalog pricing is based on the selection of standard TechnoLink finishes. Please review the TechnoLink Standard Color Cards for all Wood and Steel selections. For actual finish samples please contact Demco Customer Service.

Steel Finishes

Stardust Silver II

Additional colors may be available for an up-charge. Please contact Customer Service for special pricing.

Standard Wood Finishes (Group RUS)

Maple Veneer

Natural Maple on Maple (002)
Medium Oak on Maple (009)
Amber on Maple (015)
Dark Oak on Maple (012)
Chestnut on Maple (017)
Redwood on Maple (016)

Oak Veneer

Natural Oak on Red Oak (001)
Medium Oak on Red Oak (009)
Amber on Red Oak (015)
Dark Oak on Red Oak (012)
Chestnut on Red Oak (017)
Redwood on Red Oak (016)

Coordinating Laminates

WilsonArt Kensington Maple 10776-60
No coordinating laminate
WilsonArt Monticello Maple 7925-38
No coordinating laminate
No coordinating laminate
No coordinating laminate

WilsonArt Castle Oak 7928-38
WilsonArt Solar Oak 7816-60
WilsonArt Tuscan Walnut 7921-38
Formica Oiled Legno 8846-58
WilsonArt Montana Walnut 7110K-78
WilsonArt Zanzibar 7957K-78

Standard Wood Finishes (Group TLK)

Maple Veneer

Butterscotch on Maple (BUT)
Flax on Maple (FLX)
Cinnamon on Maple (CIN)
Venetian on Maple (VEN)

Oak Veneer

Ecrú on Oak (ECU)
Citron on Oak (CIT)
Desert on Oak (DES)
Honey on Oak (HNY)
Henna on Oak (HEN)
Nut Brown on Oak (NUT)
Canyon on Oak (CAN)
Brownie on Oak (BRW)

Coordinating Laminates

No coordinating laminate
No coordinating laminate
WilsonArt Brighton Walnut 7922K-07
WilsonArt Empire Mahogany 7122K-07

WilsonArt Castle Oak 7928-38
Pionite Taj Teak WT471 Suede
Pionite Taj Teak WT741 Suede
No coordinating laminate
WilsonArt Amber Cherry 7919K-78
WilsonArt Hampton Walnut 7959K-78
WilsonArt Empire Mahogany 7122K-07
WilsonArt Empire Mahogany 7122K-07

Please note: Because wood is a natural material, often with naturally-occurring variations in color, please be aware that texture and grain pattern may vary. If this is not acceptable to you we recommend that you choose a light stain or instead choose a woodgrain laminate.

Additional wood species may be available for an up-charge. Please contact Customer Service for special pricing.



ORDERING INFORMATION

Custom Color Up-charges

Custom color matching on Wood finishes may be subject to special pricing. Demco may request an actual finish sample to match before providing a firm quote on color up-charges. Demco will provide color samples of the custom color. **Samples must be approved in writing before order is accepted for a firm shipping date.** Please contact Customer Service for more information.

Order Changes

Order changes must always be confirmed to Demco in writing and are subject to the company's ability to conform. Demco will issue a new Order Acknowledgment for each change. Lead times may be adjusted by Demco if necessary to accommodate order changes.

Acknowledged orders will be changed without penalty prior to their production. Administrative and/or labor charges may be incurred by the customer depending upon the production stage of the order. Once final production has begun, no changes can be accepted.

Cancellation of Orders

By submitting an order to Demco, you are accepting responsibility for beginning the procurement of products wherein returns or cancellations of customized products are generally not allowed. You may not cancel an order, in whole or in part, without the written consent of Demco. No cancellation will be accepted by Demco except on terms that will fully indemnify and reimburse Demco against loss, including recovery of all costs incurred by Demco, and including indirect and overhead charges and profit.

Special Marking and Packaging

Custom crating, marking, palletizing or export packaging is subject to special pricing; and quotations must be made in advance of order placement. Contact Demco Customer Service to determine exact charges.

Shipment Terms

TechnoLink products ship FOB destination.

Payment Terms

You hereby give Demco permission to make all the reasonable inquiries into your credit history. Following such reviews, Demco will notify you of the payment terms for your orders, which will be one of the following:

- **Net 30 Days** If these terms apply to you, all amounts due under this contract shall be paid within 30 days following your receipt of an invoice.
- **25% Down, Net 30 Days** If these terms apply to you, you must pay 25% of the contract upon notice from Demco of the terms of payment, and the remaining amount due shall be paid within 30 days following the receipt of an invoice.
- **50% Down, Net 30 Days** If these terms apply to you, you must pay 50% of the contract upon notice from Demco of the terms of payment, and the remaining amount due shall be paid within 30 days following the receipt of an invoice.
- **100% Down or Payment Bond** If these terms apply to you, all amounts due under this contract shall be paid upon notice from Demco of the terms of payment. Alternatively, you may provide a payment bond or other security acceptable to Demco.

If you are required to make a down payment under the preceding payment terms, Demco will not process your order for Products under this contract until such down payment is received by Demco. You agree that you will not withhold payment of any amount due because of any other claims or set-off you may have against Demco.



ORDERING INFORMATION

Damaged Shipments

Demco's responsibility for shipment shall cease upon delivery to the carrier. Any claims for damages or loss occurring in shipment shall be made by Demco on your behalf directly to the carrier. All other claims for damages, defects, loss, shortages or incorrect Products must be made within fourteen (14) days after receipt of the Products, unless otherwise agreed by the parties in writing. Your failure to make any claim within the specified time period will result in the unconditional waiver of that claim.

Demco reserves the right to accept or reject any claim in whole or in part. Demco shall not be responsible for any defects caused by your willful or negligent acts, incorrect storage or installation of the Products, or normal wear and tear. Any claims based on the warranty shall be made within the period prescribed by the warranty.

Taxes

Any manufacturer's sales or excise tax, or any other tax or government charge now or hereafter levied upon the products, sales or use or shipment of goods shall, at the Company's option, be charged to the customer.

Warranty

Demco warrants to the original purchaser only will be free from defects in material and workmanship, given normal use, for a period of five (5) years from the date of the initial delivery on the terms and conditions set forth below.

If such a defect is found to exist during the warranty period, the original purchaser's sole remedy will be the repair or replacement, whichever Demco selects, of the product at no cost to the purchaser. All replaced products or product parts shall become the property of Demco.

The purchaser shall promptly notify Demco of any defect. No product will be accepted for warranty work without prior written approval of Demco's authorized personnel.

Defects resulting from abuse, misuse, improper storage, alteration, unauthorized repair or failure to follow published instructions for use or assembly are not covered by this warranty.

No corporation, firm, or individual is authorized to incur or assume for Demco any liability in connection with the sale, installation, or use of products except as stated in this warranty.

There are no other warranties relating to products expressed or implied, including any warranties of merchantability or fitness for a particular purpose, and in no event shall Demco be liable for incidental or consequential damages.

This warranty applies only to standard products that fall under the TechnoLink product line.



STATIONARY REFERENCE DESKS

GENERAL SPECIFICATIONS

The TechnoLink Static Desk System is a versatile, modular desking system that offers adjustable height and/or fixed height work surfaces, a variety of open and closed storage options, concealed cable management and fully compliant ADA access points.

CONSTRUCTION & MATERIALS

Work Surfaces

The TechnoLink work surfaces are available in two standard materials: Laminate or Corian. Both surface materials will be 30" D and 1½" thick. Laminate work surfaces will receive a ½"D solid wood edging. All work surfaces receive grommets as required.

Leg Frame

Each leg frame is constructed from 14 gauge steel and has an overall dimension of a 28" deep x 22⁵/₈" high x 4" wide. Each leg frame is designed to accept two veneer or laminate infill panels that sit fully within the surrounding frame. The leg frames also accept one electrically height adjustable or fixed height leg column and two adjustable glides. Each leg column is held in place with a laser cut top plate that is mounted to the top of the leg frame. Each fully assembled leg frame can in turn accept 2 lower front panels. Fixed height work surfaces are available in 29" high, 32" high or 39" high as standard.

Height Adjustability

If height adjustability is required, the TechnoLink desk utilizes electrically height adjustable legs and supporting electronic systems, which enable TechnoLink work surfaces to be raised and lowered at the touch of a button.

Each electrically height adjustable leg produces 700N of thrust per column. Up to four (4) legs can be raised and lowered simultaneously to raise one continuous work surface. Typical height adjustable work surface range is 29"H to 42"H. Height adjustable legs are controlled by a central control box.

The control box is a separate unit located on the underside of work surface. Each control box can accept up to four height adjustable legs and one control pad. The control box is a plug in system (not hard wire) and in turn provides power to two, three or four legs. The control pad is located on the staff side of the desk and contains two (2) buttons which allow the user to raise and lower the work surface as required, to create a more ergonomically correct working environment.

Lower Front Panel

The lower front panel is 19⁵/₈" high x 6" deep and is available in veneer as standard. The top of each lower front panel contains an internally facing 6" high x 3" deep cable management channel and one ¾" deep open channel to accept the upper front panel. Each end of the lower front panel has a cable management outlet to allow for continuous cable management through all desk modules.

Upper Front Panel

The upper front panel is constructed from perforated steel as standard. The panel is attached to the underside of the work surface above and is designed to fit into the open channel in the lower front panel. Dimensions of this upper front panel are such as to allow the panel to rise and fall within the lower front panel freely when specified with an electrically height adjustable leg set.



STATIONARY REFERENCE DESKS

CONSTRUCTION & MATERIALS

Pedestals and Storage

All mobile pedestals, mobile storage cabinets and storage drawers (both 3" or 6" high) are lockable.

Corner Units

Corner units must be installed between two desks as these modules do not include leg frames. As standard, the front panels on all corner units will be veneer.

To view examples of sample reference desk configuration, see the Sample Configurations sections in this Specification Guide.



STATIONARY REFERENCE DESKS

Straight 30"W, 36"W and 42"W

Product #	Product Description	Product Description
TechnoLink Desk Components		
Straight Desk 30"W - Inside Leg Frame Dimension		
13582580	30"W Straight Desk Laminate	Starter, Fixed Ht.
13582590	30"W Straight Desk Laminate	Starter, Adj. Ht.
13582560	30"W Straight Desk Laminate	Adder, Fixed Ht.
13582570	30"W Straight Desk Laminate	Adder, Adj. Ht.
13582700	30"W Straight Desk Corian	Starter, Fixed Ht.
13582710	30"W Straight Desk Corian	Starter, Adj. Ht.
13582680	30"W Straight Desk Corian	Adder, Fixed Ht.
13582690	30"W Straight Desk Corian	Adder, Adj. Ht.

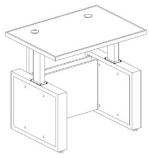

Straight Desk 36"W - Inside Leg Frame Dimension		
13582760	36"W Straight Desk Laminate	Starter, Fixed Ht.
13582770	36"W Straight Desk Laminate	Starter, Adj. Ht.
13582740	36"W Straight Desk Laminate	Adder, Fixed Ht.
13582750	36"W Straight Desk Laminate	Adder, Adj. Ht.
13582880	36"W Straight Desk Corian	Starter, Fixed Ht.
13582890	36"W Straight Desk Corian	Starter, Adj. Ht.
13582860	36"W Straight Desk Corian	Adder, Fixed Ht.
13582870	36"W Straight Desk Corian	Adder, Adj. Ht.

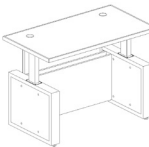

Straight Desk 42"W - Inside Leg Frame Dimension		
13582940	42"W Straight Desk Laminate	Starter, Fixed Ht.
13582950	42"W Straight Desk Laminate	Starter, Adj. Ht.
13582920	42"W Straight Desk Laminate	Adder, Fixed Ht.
13582930	42"W Straight Desk Laminate	Adder, Adj. Ht.
13583060	42"W Straight Desk Corian	Starter, Fixed Ht.
13583070	42"W Straight Desk Corian	Starter, Adj. Ht.
13583040	42"W Straight Desk Corian	Adder, Fixed Ht.
13583050	42"W Straight Desk Corian	Adder, Adj. Ht.

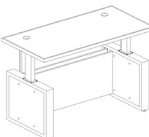

STATIONARY REFERENCE DESKS

Straight 48"W, 54"W, 60"W and 72"W

Product #	Product Description	Product Description
Straight Desk 48"W - Inside Leg Frame Dimension		
13583120	48"W Straight Desk Laminate	Starter, Fixed Ht.
13583130	48"W Straight Desk Laminate	Starter, Adj. Ht.
13583100	48"W Straight Desk Laminate	Adder, Fixed Ht.
13583110	48"W Straight Desk Laminate	Adder, Adj. Ht.
13583240	48"W Straight Desk Corian	Starter, Fixed Ht.
13583250	48"W Straight Desk Corian	Starter, Adj. Ht.
13583220	48"W Straight Desk Corian	Adder, Fixed Ht.
13583230	48"W Straight Desk Corian	Adder, Adj. Ht.

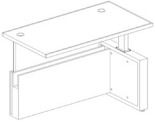
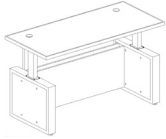

Product #	Product Description	Product Description
Straight Desk 54"W - Inside Leg Frame Dimension		
13594390	54"W Straight Desk Laminate	Starter, Fixed Ht.
13594400	54"W Straight Desk Laminate	Starter, Adj. Ht.
13594410	54"W Straight Desk Laminate	Adder, Fixed Ht.
13594420	54"W Straight Desk Laminate	Adder, Adj. Ht.
13594470	54"W Straight Desk Corian	Starter, Fixed Ht.
13594480	54"W Straight Desk Corian	Starter, Adj. Ht.
13594490	54"W Straight Desk Corian	Adder, Fixed Ht.
13594500	54"W Straight Desk Corian	Adder, Adj. Ht.

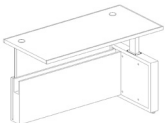
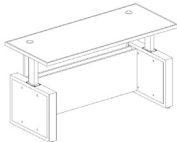

Product #	Product Description	Product Description
Straight Desk 60"W - Inside Leg Frame Dimension		
13583300	60"W Straight Desk Laminate	Starter, Fixed Ht.
13583310	60"W Straight Desk Laminate	Starter, Adj. Ht.
13583280	60"W Straight Desk Laminate	Adder, Fixed Ht.
13583290	60"W Straight Desk Laminate	Adder, Adj. Ht.
13583420	60"W Straight Desk Corian	Starter, Fixed Ht.
13583430	60"W Straight Desk Corian	Starter, Adj. Ht.
13583400	60"W Straight Desk Corian	Adder, Fixed Ht.
13583410	60"W Straight Desk Corian	Adder, Adj. Ht.

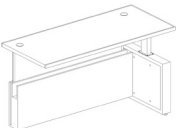
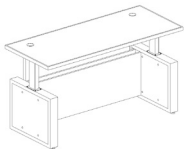

Product #	Product Description	Product Description
Straight Desk 72"W - Inside Leg Frame Dimension		
13583480	72"W Straight Desk Laminate	Starter, Fixed Ht.
13583490	72"W Straight Desk Laminate	Starter, Adj. Ht.
13583460	72"W Straight Desk Laminate	Adder, Fixed Ht.
13583470	72"W Straight Desk Laminate	Adder, Adj. Ht.
13583600	72"W Straight Desk Corian	Starter, Fixed Ht.
13583610	72"W Straight Desk Corian	Starter, Adj. Ht.
13583580	72"W Straight Desk Corian	Adder, Fixed Ht.
13583590	72"W Straight Desk Corian	Adder, Adj. Ht.

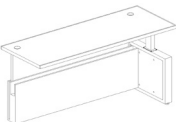
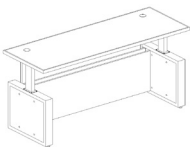



STATIONARY REFERENCE DESKS

Curved 45, 60 and 90 Degree

Product #	Product Description	Product Description
Curved Desk 45°		
13581510	45° Curved Desk Laminate	Starter, Fixed Ht.
13581520	45° Curved Desk Laminate	Starter, Adj. Ht.
13581490	45° Curved Desk Laminate	Adder, Fixed Ht.
13581500	45° Curved Desk Laminate	Adder, Adj. Ht.
13581630	45° Curved Desk Corian	Starter, Fixed Ht.
13581640	45° Curved Desk Corian	Starter, Adj. Ht.
13581610	45° Curved Desk Corian	Adder, Fixed Ht.
13581620	45° Curved Desk Corian	Adder, Adj. Ht.

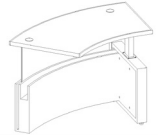
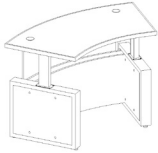

Curved Desk 60°		
13581690	60° Curved Desk Laminate	Starter, Fixed Ht.
13581700	60° Curved Desk Laminate	Starter, Adj. Ht.
13581670	60° Curved Desk Laminate	Adder, Fixed Ht.
13581680	60° Curved Desk Laminate	Adder, Adj. Ht.
13581810	60° Curved Desk Corian	Starter, Fixed Ht.
13581820	60° Curved Desk Corian	Starter, Adj. Ht.
13581790	60° Curved Desk Corian	Adder, Fixed Ht.
13581800	60° Curved Desk Corian	Adder, Adj. Ht.

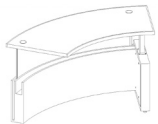
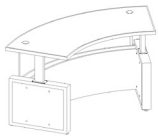

Curved Desk 90°		
13581870	90° Curved Desk Laminate	Starter, Fixed Ht.
13581850	90° Curved Desk Laminate	Adder, Fixed Ht.
13581990	90° Curved Desk Corian	Starter, Fixed Ht.
13581970	90° Curved Desk Corian	Adder, Fixed Ht.

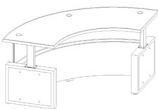



STATIONARY REFERENCE DESKS

Book Returns, ADA Compliant

Product #	Product Description	Product Description
Book Return - Fixed Height, 32" or 39" high, 36" wide - Inside Leg Frame Dimension		
13583640	Book Return Laminate	Starter, Fixed Ht.
13583630	Book Return Laminate	Adder, Fixed Ht.
13583700	Book Return Corian	Adder, Fixed Ht.
13583690	Book Return Corian	Adder, Fixed Ht.



Mobile Booktrucks		
13713640	Mobile Depressible Booktruck	for 32" H unit
13713650	Mobile Depressible Booktruck	for 39" H unit

ADA Access, Straight Desks, 36" wide - Inside Leg Frame Dimension		
13594630	ADA Access Straight Desk	Starter, Fixed Ht., Laminate
13594640	ADA Access Straight Desk	Adder, Fixed Ht., Laminate
13594670	ADA Access Straight Desk	Starter, Fixed Ht., Corian
13594680	ADA Access Straight Desk	Adder, Fixed Ht., Corian

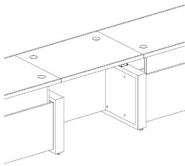

ADA Access Units
Have a Recessed
Front Panel

For clarification on ADA Access Desks, see the Sample Configurations section.

Miscellaneous Reference Desk Components		
13594860	3" Black Grommet	WITH factory installation
13582460	3" Black Grommet	To be installed in the field



STATIONARY REFERENCE DESKS

Pedestals



Product #	Product Description	Product Description
Pedestals		
13582020	Pedestal, Open w/ adj. shelf	w/ Laminate top
13582040	Pedestal, Open w/ adj. shelf	w/ Corian top



13582060	Pedestal, 2 Drawers	w/ Laminate top
13582080	Pedestal, 2 Drawers	w/ Corian top



13582100	Pedestal, 3 Drawers	w/ Laminate top
13582120	Pedestal, 3 Drawers	w/ Corian top



13582140	Pedestal w/ Door	w/ Laminate top
13582160	Pedestal w/ Door	w/ Corian top

Curved Pedestals



13764270	Curved Pedestal, Open w/ adj. shelf	w/ Laminate Top
13764280	Curved Pedestal, Open w/ adj. shelf	w/ Corian Top



13764290	Curved Pedestal w/ 2 Drawers	w/ Laminate Top
13764300	Curved Pedestal w/ 2 Drawers	w/ Corian Top



13764310	Curved Pedestal w/ 3 Drawers	w/ Laminate Top
13764320	Curved Pedestal w/ 3 Drawers	w/ Corian Top



13764330	Curved Pedestal w/ Door	w/ Laminate Top
13764340	Curved Pedestal w/ Door	w/ Corian Top



STATIONARY REFERENCE DESKS

Storage Units

Product #	Product Description
Storage Cabinets, all Veneer. Each cabinet receives 6 casters.	
13594530	35 $\frac{1}{2}$ "W Pedestal Storage Unit Mobile



13594560	41 $\frac{1}{2}$ "W Pedestal Storage Unit Mobile
----------	--



13582190	47 $\frac{1}{2}$ "W Pedestal Storage Unit Mobile
----------	--





STATIONARY REFERENCE DESKS

Bullet Tables, Corner Units and Drawers



Product #	Product Description	Product Description
Bullet Tables for Desks		
13582250	48"W Bullet Table, Straight	Laminate top
13582270	48"W Bullet Table, Straight	Corian top



13582280	65"W Bullet Table, Curved	Laminate top
13582300	65"W Bullet Table, Curved	Corian top



13582310	80"W Bullet Table, Curved	Laminate top
13582330	80"W Bullet Table, Curved	Corian top

Corner Desk Units



13594750	Corner Display Unit, Curved	Laminate
13594770	Corner Display Unit, Curved	Corian

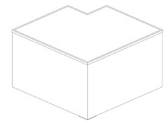

13594780	Corner Display Unit, Square	Laminate
13594800	Corner Display Unit, Square	Corian

Desk Drawers



13582400	Storage Drawer 3"H	1 Drawer - 31 1/2"W (each) - for 36"W Inside Leg Frame Desks
13582410	Storage Drawer 3"H	2 Drawer - 21 1/2"W (each) - for 48"W Inside Leg Frame Desks
13582420	Storage Drawer 3"H	2 Drawer - 27 1/2"W (each) - for 60"W Inside Leg Frame Desks
13582430	Storage Drawer 6"H	1 Drawer - 31 1/2"W (each) - for 36"W Inside Leg Frame Desks
13582440	Storage Drawer 6"H	2 Drawer - 21 1/2"W (each) - for 48"W Inside Leg Frame Desks
13582450	Storage Drawer 6"H	2 Drawer - 27 1/2"W (each) - for 60"W Inside Leg Frame Desks

PLAN A

3D VIEWS

PLAN VIEW

Components List

- QTY 2 – P/N 135 81690 - 60 Degree Starter – Fixed Height - Laminate Work Surface
- QTY 2 – P/N 135 81670 - 60 Degree Adder – Fixed Height - Laminate Work Surface
- QNTY 1 – P/N 135-82060 - 2 Drawer Pedestal – Laminate Top
- QNTY 1 – P/N 135-82280 – 65” wide Bullet Table, Curved

PLAN B

3D VIEWS

PLAN VIEW

Components List

- QTY 4 – P/N 135 82760 – 36” wide Straight Desk Starter – Fixed Height - Laminate Work Surface
- QTY 3 – P/N 135 82740 – 36” wide Straight Desk Adder – Fixed Height - Laminate Work Surface
- QTY 1 – P/N 135 94640 – 36” wide ADA Desk Adder – Fixed Height - Laminate Work Surface
- QNTY 2 – P/N 135-82060 - 2 Drawer Pedestal – Laminate Top

PLAN C

3D VIEWS

PLAN VIEW

Components List

- QTY 1 – P/N 135 82940 – 42" wide Straight Desk Starter – Fixed Height - Laminate Work Surface
- QTY 2 – P/N 135 82920 – 42" wide Straight Desk Adder – Fixed Height - Laminate Work Surface
- QTY 1 – P/N 135 81690 – 60 Degree Starter – Fixed Height - Laminate Work Surface
- QTY 2 – P/N 135 81670 – 60 Degree Adder – Fixed Height - Laminate Work Surface

PLAN D

3D VIEWS

PLAN VIEW

Components List

- QTY 2 – P/N 135 81690 – 60 Degree Starter – Fixed Height - Laminate Work Surface
- QNTY 1 – P/N 135-82060 – 2 Drawer Pedestal – Laminate Top

PLAN E

3D VIEWS

PLAN VIEW

Components List

QTY 2 – P/N 135 81690 - 60 Degree Starter – Fixed Height - Laminate Work Surface

QTY 1 – P/N 135 83120 – 48” wide Straight Desk Starter – Fixed Height - Laminate Work Surface

QNTY 2 – P/N 135-82060 - 2 Drawer Pedestal – Laminate Top

PLAN F

3D VIEWS

PLAN VIEW

Components List

QTY 3 – P/N 135 81690 - 60 Degree Starter – Fixed Height - Laminate Work Surface

QNTY 2 – P/N 135-82060 - 2 Drawer Pedestal – Laminate Top

PLAN G

3D VIEWS

PLAN VIEW

Components List

- QTY 4 – P/N 135 83120 – 48” wide Straight Desk Starter – Fixed Height - Laminate Work Surface
- QNTY 1 – P/N 135-82060 - 2 Drawer Pedestal – Laminate Top
- QNTY 2 – P/N 135-94750 - Corner Display – Laminate Top

PLAN H

3D VIEWS

PLAN VIEW

Components List

- QTY 3 – P/N 135 83120 – 48” wide Straight Desk Starter – Fixed Height - Laminate Work Surface
- QNTY 1 – P/N 135 82060 - 2 Drawer Pedestal – Laminate Top
- QNTY 1 – P/N 135 94750 - Corner Display – Laminate Top
- QNTY 1 – P/N 135 82250 – Bullet Table 48” wide

PLAN J

3D VIEWS

PLAN VIEW

Components List

- QTY 1 – P/N 135 82760 – 36" wide Straight Desk Starter – Fixed Height - Laminate Work Surface
- QTY 1 – P/N 135 81850 - 90 Degree Adder – Fixed Height - Laminate Work Surface
- QTY 2 – P/N 135 83120 – 48" wide Straight Desk Starter – Fixed Height - Laminate Work Surface
- QNTY 2 – P/N 135 82060 - 2 Drawer Pedestal – Laminate Top

PLAN K

3D VIEWS

PLAN VIEW

Components List

- QTY 2 – P/N 135 82760 – 36" wide Straight Desk Starter – Fixed Height - Laminate Work Surface
- QTY 2 – P/N 135 81850 - 90 Degree Adder – Fixed Height - Laminate Work Surface
- QTY 1 – P/N 135 83120 – 48" wide Straight Desk Starter – Fixed Height - Laminate Work Surface
- QNTY 2 – P/N 135 82060 - 2 Drawer Pedestal – Laminate Top

CABINET STORAGE

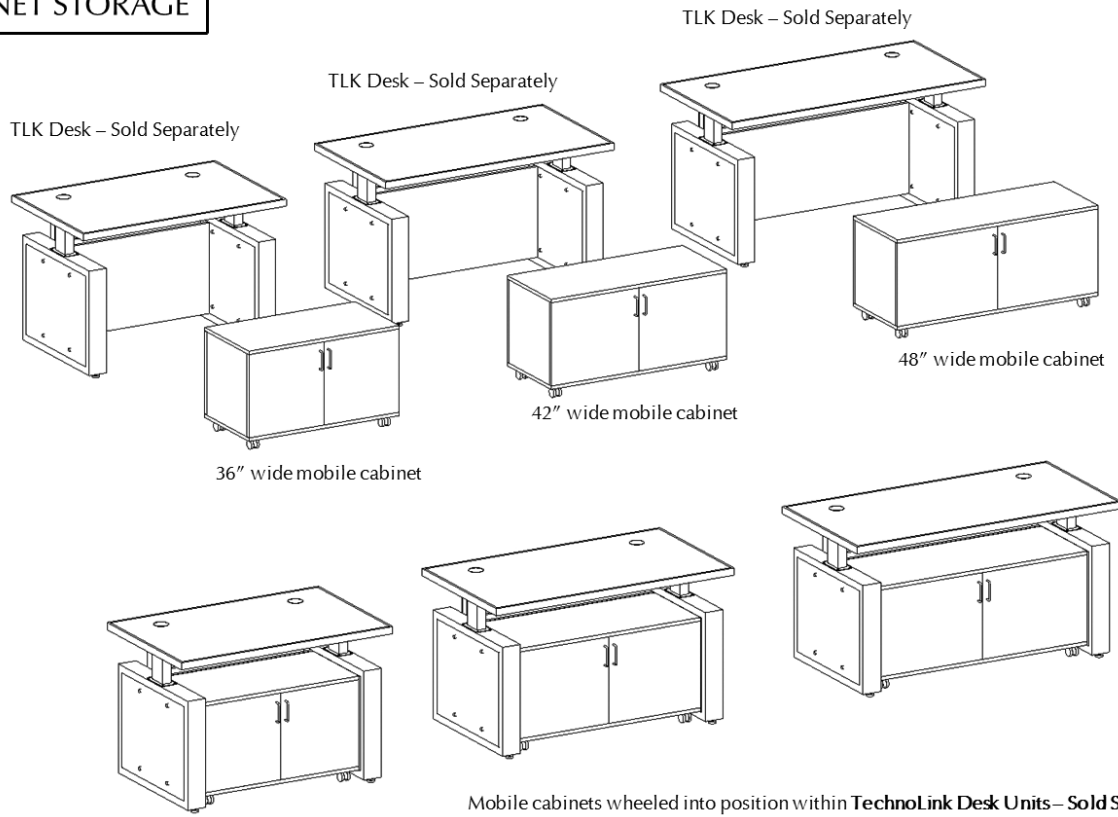

36" wide cabinet has 1 adjustable shelf. 42" and 48" have 2 adjustable shelves and 1 central vertical divider.
 36" wide cabinet (P/N 135 94530) , 42" wide cabinet (P/N 135 94560), 48" wide cabinet (P/N 135 82190).



GENERAL SPECIFICATIONS

The TechnoLink Mobile Desk System is a versatile, modular desking system that offers adjustable height and/or fixed height work surfaces, a variety of open and closed storage options, concealed cable management and fully compliant ADA access points.

CONSTRUCTION & MATERIALS

Work Surfaces

The TechnoLink work surfaces are available in two standard materials: Laminate or Corian. Both surface materials will be 30"D and 1½" thick. Laminate work surfaces will receive a ½"D solid wood edging. All work surfaces receive grommets as required.

Height Adjustability

If height adjustability is required, the TechnoLink desk utilizes electrically height adjustable legs and supporting electronic systems, which enable TechnoLink work surfaces to be raised and lowered at the touch of a button.

Each electrically height adjustable leg produces 700N of thrust per column. Typical height adjustable work surface range is 29"H to 42"H. Height adjustable legs are controlled by a central control box.

The control box is a separate unit located on the underside of work surface. Each control box can accept up to four height adjustable legs and one control pad. The control box is a plug in system (not hard wire) and in turn provides power to two, three or four legs. The control pad is located on the staff side of the desk and contains 2 buttons which allow the user to raise and lower the work surface as required, to create a more ergonomically correct working environment.

Lower Base Module

The lower base module is 19" high and are available in either a veneer as standard. The top of each base is finished with a ¾" thick Colorich surface, resulting in an overall combined height of 19¾".

Each desk includes a 3" x 3" internally facing cable management channel and a ¾" top facing slot to accept the upper front panel. Each lower base panel includes as standard two grommets (2" diameter) mounted on the exterior vertical side walls that allow for continuous cable management through the unit.

Upper Front Panel

The upper front panel is constructed from perforated steel. The panel is attached to the underside of the work surface above, and is designed to locate into the open channel in the lower base panel. Dimensions of this upper front panel are such as to allow the panel to rise and fall within the lower front panel freely when specified with an electrically height adjustable leg set.

Casters

Each desk will be supported by 3" diameter casters. All casters will be lockable. Caster color will be gray. Weight loading per caster is 165 lbs.

To view examples of sample mobile reference desk configurations, see the Sample Configurations section.



MOBILE REFERENCE DESKS

Straight ADA, 48"W and 54"W



Product #	Product Description	Product Description
TechnoLink Mobile - Straight ADA Desk / No Pedestal - 48"W Work Surface		
13713310	Mobile ADA Desk 48"W	Laminate, No Pedestal, Fixed Ht.
13713330	Mobile ADA Desk 48"W	Corian, No Pedestal, Fixed Ht.



TechnoLink Mobile - Straight Desk / No Pedestal - 48"W Work Surface		
13710710	Mobile Straight Desk 48"W	Laminate, No Pedestal, Fixed Ht.
13710720	Mobile Straight Desk 48"W	Laminate, No Pedestal, Adj. Ht.
13710750	Mobile Straight Desk 48"W	Corian, No Pedestal, Fixed Ht.
13710760	Mobile Straight Desk 48"W	Corian, No Pedestal, Adj. Ht.

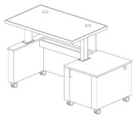

Shown w/
Right Hand (RH) Ped

TechnoLink Mobile - Straight Desk / Pedestal - 48"W Work Surface		
13710770	Mobile Straight Desk 48"W	Laminate, Right-hand Pedestal, Fixed Ht.
13710780	Mobile Straight Desk 48"W	Laminate, Right-hand Pedestal, Adj. Ht.
13710810	Mobile Straight Desk 48"W	Corian, Right-hand Pedestal, Fixed Ht.
13710820	Mobile Straight Desk 48"W	Corian, Right-hand Pedestal, Adj. Ht.
13710830	Mobile Straight Desk 48"W	Laminate, Left-hand Pedestal, Fixed Ht.
13710840	Mobile Straight Desk 48"W	Laminate, Left-hand Pedestal, Adj. Ht.
13710870	Mobile Straight Desk 48"W	Corian, Left-hand Pedestal, Fixed Ht.
13710880	Mobile Straight Desk 48"W	Corian, Left-hand Pedestal, Adj. Ht.



TechnoLink Mobile - Straight Desk / No Pedestal - 54"W Work Surface		
13710890	Mobile Straight Desk 54"W	Laminate, No Pedestal, Fixed Ht.
13710900	Mobile Straight Desk 54"W	Laminate, No Pedestal, Adj. Ht.
13710930	Mobile Straight Desk 54"W	Corian, No Pedestal, Fixed Ht.
13710940	Mobile Straight Desk 54"W	Corian, No Pedestal, Adj. Ht.



Shown w/
Right Hand (RH) Ped

TechnoLink Mobile - Straight Desk / Pedestal - 54"W Work Surface		
13710950	Mobile Straight Desk 54"W	Laminate, Right-hand Pedestal, Fixed Ht.
13710960	Mobile Straight Desk 54"W	Laminate, Right-hand Pedestal, Adj. Ht.
13710990	Mobile Straight Desk 54"W	Corian, Right-hand Pedestal, Fixed Ht.
13711000	Mobile Straight Desk 54"W	Corian, Right-hand Pedestal, Adj. Ht.
13711010	Mobile Straight Desk 54"W	Laminate, Left-hand Pedestal, Fixed Ht.
13711020	Mobile Straight Desk 54"W	Laminate, Left-hand Pedestal, Adj. Ht.
13711050	Mobile Straight Desk 54"W	Corian, Left-hand Pedestal, Fixed Ht.
13711060	Mobile Straight Desk 54"W	Corian, Left-hand Pedestal, Adj. Ht.



MOBILE REFERENCE DESKS

Straight 60"W and 72"W



Product #	Product Description	Product Description
TechnoLink Mobile - Straight Desk / No Pedestal - 60"W Work Surface		
13711070	Mobile Straight Desk 60"W	Laminate, No Pedestal, Fixed Ht.
13711080	Mobile Straight Desk 60"W	Laminate, No Pedestal, Adj. Ht.
13711110	Mobile Straight Desk 60"W	Corian, No Pedestal, Fixed Ht.
13711120	Mobile Straight Desk 60"W	Corian, No Pedestal, Adj. Ht.

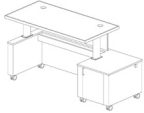

Shown w/
Right Hand (RH) Ped

TechnoLink Mobile - Straight Desk / Pedestal - 60"W Work Surface		
13711130	Mobile Straight Desk 60"W	Laminate, Right-hand Pedestal, Fixed Ht.
13711140	Mobile Straight Desk 60"W	Laminate, Right-hand Pedestal, Adj. Ht.
13711170	Mobile Straight Desk 60"W	Corian, Right-hand Pedestal, Fixed Ht.
13711180	Mobile Straight Desk 60"W	Corian, Right-hand Pedestal, Adj. Ht.
13711190	Mobile Straight Desk 60"W	Laminate, Left-hand Pedestal, Fixed Ht.
13711200	Mobile Straight Desk 60"W	Laminate, Left-hand Pedestal, Adj. Ht.
13711230	Mobile Straight Desk 60"W	Corian, Left-hand Pedestal, Fixed Ht.
13711240	Mobile Straight Desk 60"W	Corian, Left-hand Pedestal, Adj. Ht.

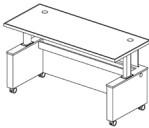

TechnoLink Mobile - Straight Desk / No Pedestal - 72"W Work Surface		
13711370	Mobile Straight Desk 72"W	Laminate, No Pedestal, Fixed Ht.
13711380	Mobile Straight Desk 72"W	Laminate, No Pedestal, Adj. Ht.



Shown w/
Right Hand (RH) Ped

TechnoLink Mobile - Straight Desk / Pedestal - 72"W Work Surface		
13711410	Mobile Straight Desk 72"W	Laminate, Right-hand Pedestal, Fixed Ht.
13711420	Mobile Straight Desk 72"W	Laminate, Right-hand Pedestal, Adj. Ht.
13711450	Mobile Straight Desk 72"W	Laminate, Left-hand Pedestal, Fixed Ht.
13711460	Mobile Straight Desk 72"W	Laminate, Left-hand Pedestal, Adj. Ht.



MOBILE REFERENCE DESKS

Curved 28 and 46¼ Degrees



Product #	Product Description	Product Description
TechnoLink Mobile - 28° Curved Desk w/ Pedestal		
13594330	Mobile 28° Curved Desk	Laminate, w/ Signage & Pedestal, Fixed Ht.
13594350	Mobile 28° Curved Desk	Corian, w/ Signage & Pedestal, Fixed Ht.
13594360	Mobile 28° Curved Desk	Laminate, w/ Signage & Pedestal, Adj. Ht.
13594380	Mobile 28° Curved Desk	Corian, w/ Signage & Pedestal, Adj. Ht.

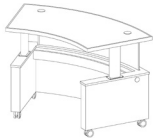

TechnoLink Mobile - 46¼° Curved Desk / No Pedestal		
13711490	Mobile 46¼° Curved Desk	Laminate, No Pedestal, Fixed Ht.
13711500	Mobile 46¼° Curved Desk	Laminate, No Pedestal, Adj. Ht.
13711530	Mobile 46¼° Curved Desk	Corian, No Pedestal, Fixed Ht.
13711540	Mobile 46¼° Curved Desk	Corian, No Pedestal, Adj. Ht.



TechnoLink Mobile - 46¼° Curved ADA Desk / No Pedestal		
13713070	Mobile 46¼° ADA Desk	Laminate, No Pedestal, Fixed Ht.
13713090	Mobile 46¼° ADA Desk	Corian, No Pedestal, Fixed Ht.

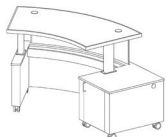

Shown w/
Right Hand (RH) Ped

TechnoLink Mobile - 46¼° Curved Desk / Straight Pedestal		
13711550	Mobile 46¼° Curved Desk	Laminate, Right-hand Straight Pedestal, Fixed Ht.
13711560	Mobile 46¼° Curved Desk	Laminate, Right-hand Straight Pedestal, Adj. Ht.
13711590	Mobile 46¼° Curved Desk	Corian, Right-hand Straight Pedestal, Fixed Ht.
13711600	Mobile 46¼° Curved Desk	Corian, Right-hand Straight Pedestal, Adj. Ht.
13711610	Mobile 46¼° Curved Desk	Laminate, Left-hand Straight Pedestal, Fixed Ht.
13711620	Mobile 46¼° Curved Desk	Laminate, Left-hand Straight Pedestal, Adj. Ht.
13711650	Mobile 46¼° Curved Desk	Corian, Left-hand Straight Pedestal, Fixed Ht.
13711660	Mobile 46¼° Curved Desk	Corian, Left-hand Straight Pedestal, Adj. Ht.

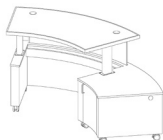

Shown w/
Right Hand (RH) Ped

TechnoLink Mobile - 46¼° Curved Desk / Curved Pedestal		
13711670	Mobile 46¼° Curved Desk	Laminate, Right-hand Curved Pedestal, Fixed Ht.
13711680	Mobile 46¼° Curved Desk	Laminate, Right-hand Curved Pedestal, Adj. Ht.
13711710	Mobile 46¼° Curved Desk	Corian, Right-hand Curved Pedestal, Fixed Ht.
13711720	Mobile 46¼° Curved Desk	Corian, Right-hand Curved Pedestal, Adj. Ht.
13711730	Mobile 46¼° Curved Desk	Laminate, Left-hand Curved Pedestal, Fixed Ht.
13711740	Mobile 46¼° Curved Desk	Laminate, Left-hand Curved Pedestal, Adj. Ht.
13711770	Mobile 46¼° Curved Desk	Corian, Left-hand Curved Pedestal, Fixed Ht.
13711780	Mobile 46¼° Curved Desk	Corian, Left-hand Curved Pedestal, Adj. Ht.



MOBILE REFERENCE DESKS

Curved 56 and 70 Degrees

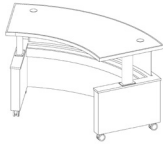

Product #	Product Description	Product Description
TechnoLink Mobile - 56° Curved Desk / No Pedestal		
13711790	Mobile 56° Curved Desk	Laminate, No Pedestal, Fixed Ht.
13711800	Mobile 56° Curved Desk	Laminate, No Pedestal, Adj. Ht.
13711830	Mobile 56° Curved Desk	Corian, No Pedestal, Fixed Ht.
13711840	Mobile 56° Curved Desk	Corian, No Pedestal, Adj. Ht.



TechnoLink Mobile - 56° Curved ADA Desk / No Pedestal		
13713220	Mobile 56° ADA Desk	Laminate, No Pedestal, Fixed Ht.
13713240	Mobile 56° ADA Desk	Corian, No Pedestal, Fixed Ht.

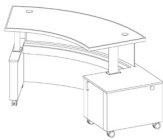

Shown w/
Right Hand (RH) Ped

TechnoLink Mobile - 56° Curved Desk / Straight Pedestal		
13711850	Mobile 56° Curved Desk	Laminate, Right-hand Straight Pedestal, Fixed Ht.
13711860	Mobile 56° Curved Desk	Laminate, Right-hand Straight Pedestal, Adj. Ht.
13711890	Mobile 56° Curved Desk	Corian, Right-hand Straight Pedestal, Fixed Ht.
13711900	Mobile 56° Curved Desk	Corian, Right-hand Straight Pedestal, Adj. Ht.
13711910	Mobile 56° Curved Desk	Laminate, Left-hand Straight Pedestal, Fixed Ht.
13711920	Mobile 56° Curved Desk	Laminate, Left-hand Straight Pedestal, Adj. Ht.
13711950	Mobile 56° Curved Desk	Corian, Left-hand Straight Pedestal, Fixed Ht.
13711960	Mobile 56° Curved Desk	Corian, Left-hand Straight Pedestal, Adj. Ht.

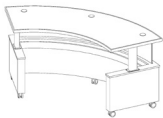

TechnoLink Mobile - 70° Curved Desk / No Pedestal		
13711970	Mobile 70° Curved Desk	Laminate, No Pedestal, Fixed Ht.
13711980	Mobile 70° Curved Desk	Laminate, No Pedestal, Adj. Ht.



MOBILE REFERENCE DESKS

Mobile Storage Units and Drawers

Product #	Product Description	Product Description
TechnoLink Mobile - Mobile Storage Units		
13712750	Mobile Storage Open Shelf	for 48"W Desk, Veneer Top



13712760	Mobile Storage Cabinet	for 48"W Desk, Veneer Top
----------	------------------------	---------------------------



13712770	Mobile Storage Open Shelf	for 46 1/4 Degree Desk, Veneer Top
----------	---------------------------	------------------------------------



13712780	Mobile Storage Cabinet	for 46 1/4 Degree Desk, Veneer Top
----------	------------------------	------------------------------------



13712790	Mobile Storage Open Shelf	for 56 Degree Desk, Veneer Top
----------	---------------------------	--------------------------------



13712800	Mobile Storage Cabinet	for 56 Degree Desk, Veneer Top
----------	------------------------	--------------------------------



TechnoLink Mobile - Drawers - Straight Front

13712810	Pencil Drawer 3" H Curved Front	17 3/4"Wx16"D, No Pulls/Locks
13712820	Pencil Drawer 3" H Straight Front	17 3/4"Wx16"D, No Pulls/Locks
13712830	Storage Drawer for 42 1/4"W Unit	3"Hx26"W, No Pulls/Locks
13712840	Storage Drawer for 42 1/4"W Unit	6"Hx26"W, Pulls/Locks Included
13712890	Storage Drawer for 54"W Unit	3"Hx37 1/2"W, No Pulls/Locks
13712900	Storage Drawer for 54"W Unit	6"Hx37 1/2"W, Pulls/Locks Included
13712950	Storage Drawers for 66"W Unit	Qty 2, 3"Hx24 1/2"W, No Pulls/Locks
13712960	Storage Drawers for 66"W Unit	Qty 2, 6"Hx24 1/2"W, Pulls/Locks Included
13712980	Storage Drawers for 72"W Unit	Qty 2, 3"Hx26"W, No Pulls/Locks
13712990	Storage Drawers for 72"W Unit	Qty 2, 6"Hx26"W, Pulls/Locks Included

TechnoLink Mobile - Drawers - Curved Front

13713010	Curved Front for 46 1/4° Unit	3"Hx26"W, No Pulls/Locks
13713020	Curved Front for 46 1/4° Unit	6"Hx26"W, Pulls/Locks Included
13713040	Curved Front for 56° & 70° Unit	3"Hx32"W, No Pulls/Locks
13713050	Curved Front for 56° & 70° Unit	6"Hx32"W, Pulls/Locks Included



MOBILE REFERENCE DESKS

Book Returns and Corner Units

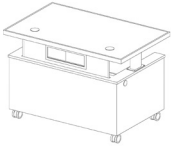
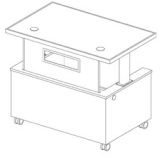

Product #	Product Description	Product Description
TechnoLink Mobile - Straight Book Return - 48"W		
13713460	Mobile Straight Book Return	Laminate, Front Slot, 39"Hx48"W
13713480	Mobile Straight Book Return	Corian, Front Slot, 39"Hx48"W
13713490	Mobile Straight Book Return	Laminate, Front Slot, 32"Hx48"W
13713510	Mobile Straight Book Return	Corian, Front Slot, 32"Hx48"W

Mobile Booktrucks		
13713640	Mobile Depressible Booktruck	for 32"H unit
13713650	Mobile Depressible Booktruck	for 39"H unit



TechnoLink Mobile - Corner Units		
13713690	Mobile 90° Curved Corner	Laminate, Pedestal Table, Fixed Ht.
13713710	Mobile 90° Curved Corner	Corian, Pedestal Table, Fixed Ht.

PLAN A

3D VIEWS

PLAN VIEW

Components List

QTY 4 – P/N 137 11670 - 46.25 Degree Curved Desk w/ Curved Right Hand Ped

PLAN B

3D VIEWS

PLAN VIEW

Components List

QTY 1 – 137 10770 - 48"W Straight Desk w/ Right Hand Ped

QTY 2 – 137 11850 - 56 Degree Curved Desk w/ Straight Right Hand Ped

QTY 1 – 137 13490 – Straight Book Return – Front Slot

QNTY 1 – 137 13640 – Mobile Depressible Book Truck (Not Shown)

PLAN C

3D VIEWS

PLAN VIEW

Components List

- QTY 2 – 137 11670 - 46.25 Degree Curved Desk w/ Curved Right Hand Ped
- QTY 1 – 137 11490 - 46.25 Degree Curved Desk

PLAN D

3D VIEWS

PLAN VIEW

Components List

- QTY 3 – 137 11550 - 46.25 Degree Curved Desk w/ Straight Right Hand Ped
- QTY 1 – 137 11490 - 46.25 Degree Curved Desk

PLAN E

3D VIEWS

PLAN VIEW

Components List

- QTY 1 – 137 10770 - 48"W Straight Desk w/ Right Hand Ped
- QTY 1 – 137 11670 - 46.25 Degree Curved Desk w/ Curved Right Hand Ped
- QTY 1 – 137 11550 - 46.25 Degree Curved Desk
- QTY 1 – 137 10830 - 48"W Straight Desk w/ Left Hand Ped

PLAN F

3D VIEWS

PLAN VIEW

Components List

- QTY 2 – 137 11850 - 56 Degree Curved Desk w/ Straight Right Hand Ped
- QTY 1 – 137 11790 - 56 Degree Curved Desk

PLAN G

3D VIEWS

16' - 4 15/32"

56.00"

56.00"

5' - 4 3/32"

46.25"

52.98"

PLAN VIEW

Components List

- QTY 1 – 137 11550 - 46.25 Degree Curved Desk w/ Straight Right Hand Ped
- QTY 2 – 137 11850 - 56 Degree Curved Desk w/ Straight Right Hand Ped
- QTY 1 – 137 11490 - 46.25 Degree Curved Desk

PLAN H

3D VIEWS

16' - 10 25/32"

5' - 0"

46.25"

46.25"

5' - 3 9/16"

PLAN VIEW

Components List

- QTY 1 – 137 11670 - 46.25 Degree Curved Desk w/ Curved Right Hand Ped
- QTY 1 – 137 11730 - 46.25 Degree Curved Desk w/ Curved Left Hand Ped
- QTY 1 – 137 11070 - 60"W Straight Desk

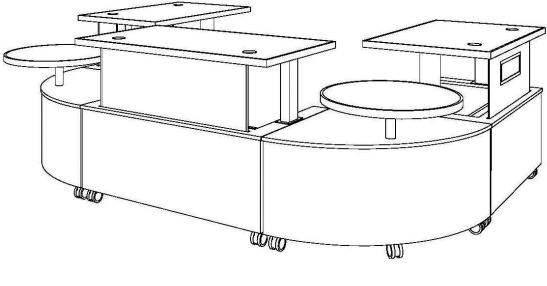
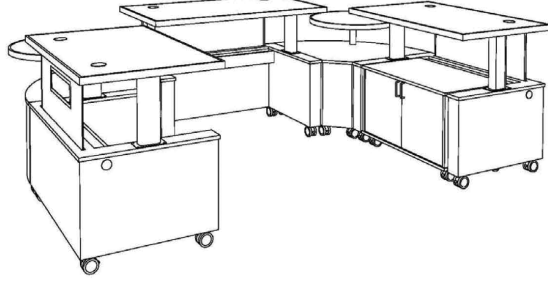
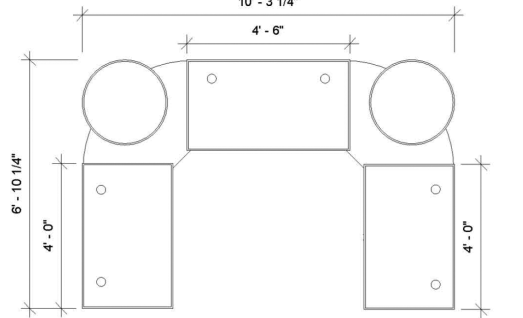
<p>PLAN J</p>  <p>3D VIEW 1</p>	 <p>3D VIEW 2</p>
 <p>PLAN VIEW</p>	<p><u>Components List</u></p> <p>QTY 1 – 137 13460 - Book Return w/ Upper Front Slot</p> <p>QTY 1 – 137 13650 – Mobile Depressible Book Truck (not shown)</p> <p>QTY 2– 137 13690 - 90 Degree Curved Corner Unit w/ Pedestal Table</p> <p>QTY 1 – 137 10890 - 54"W Straight Desk</p> <p>QTY 1 – 137 10710 - 48"W Straight Desk</p> <p>QTY 1 – 137 12760 - Cabinet for 48"W Desk</p>

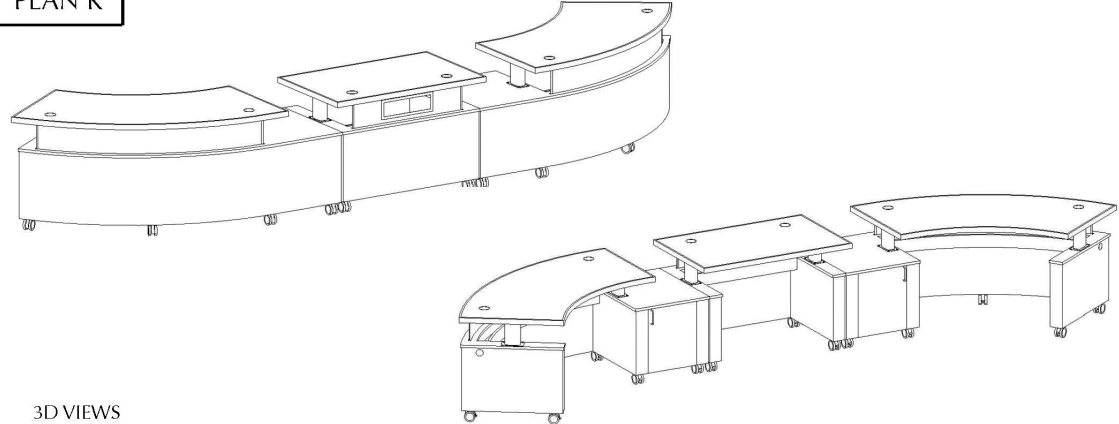
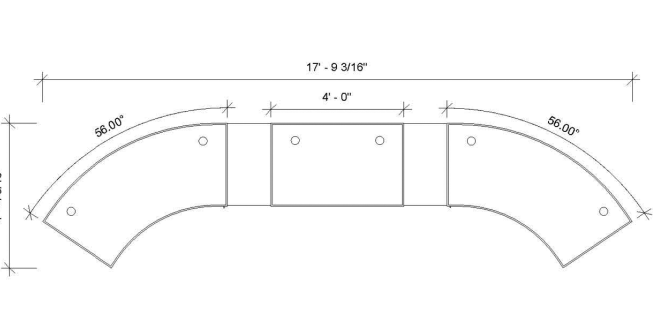
<p>PLAN K</p>  <p>3D VIEWS</p>	
 <p>PLAN VIEW</p>	<p><u>Components List</u></p> <p>QTY 1 – 137 11850 - 56 Degree Curved Desk w/ Straight Right Hand Ped</p> <p>QTY 1 – 137-13490 - 48"W Book Return w/ Front Slot</p> <p>QTY 1 – 137-13640 – Mobile Depressible Book Truck (not shown)</p> <p>QTY 1 – 137 11910 - 56 Degree Curved Desk w/ Straight Left Hand Pedestal</p>

PLAN L

3D VIEWS

PLAN VIEW

Components List

QTY 1 – 137 11850 - 56 Degree Curved Desk w/ Straight Right Hand Ped

QTY 1 – 137-13310 – 48” Wide ADA Desk

QTY 1 – 137 11910 - 56 Degree Curved Desk w/ Straight Left Hand Pedestal

PLAN M

3D VIEW 1

3D VIEW 2

PLAN VIEW

Components List

QTY 2 – 137 11070 - 60”W Straight Desk

QTY 1 – 137 13690 - 90 Degree Curved Corner Unit w/ Pedestal Table

PLAN N

3D VIEW

PLAN VIEW

Components List

- QTY 2-137 11130 - 60"W Straight Desk w/ Right Hand Ped
- QTY 2-137 11190 - 60"W Straight Desk w/ Left Hand Ped
- QTY 2 - 137 10710 - 48"W Straight Desk
- QTY 2 - 137 12760 - 48"W Straight Cabinet

PLAN O

3D VIEWS

PLAN VIEW

Components List

- QTY 1 - 137 11130 - 60"W Straight Desk with right hand pedestal
- QTY 1 - 137 11190 - 60"W Straight Desk with left hand pedestal
- QTY 1 - 137 10710 - 48"W Straight Desk

PLAN P

3D VIEWS

PLAN VIEW

Components List

- QTY 1 – 137 11850 - 56 Degree Curved Desk w/ Straight Ped
- QTY 1 – 137 13220 - 56 Degree Curved ADA Desk

PLAN Q

3D VIEWS

PLAN VIEW

Components List

- QTY 1 – 137 11550 - 46.25 Degree Curved Desk w/ Straight Right Hand Ped
- QTY 1 – 137 11490 - 46.25 Degree Curved Desk
- QTY 1 – 137 12780 - Cabinet Storage for 46.25 Degree Desk

GENERAL SPECIFICATIONS

TechnoLink Media Tables allow multiple users in a group to share ideas and information electronically on one larger monitor. Available in two (2) size table tops, up to six (6) users can collaborate together using a media sharing software that is easily plugged into each user's individual device.

CONSTRUCTION & MATERIALS

Table tops are 29"H x 55"W and can be either 80"D or 66"D depending on preference and available space. Surfaces are scratch resistant 1.5" thick high pressure laminate (HPL) with PVC edge band. They are rounded at one end and fastened to the vertical back panel at the other.

Vertical back panel is constructed from 2 panels surfaced with HPL and then captured within a solid maple frame. The left and right hand sides of back panel accept two frosted acrylic inserts.

Each TechnoLink Media Table is suited to accommodate a 42" diagonal monitor (not included) and will accept 2-person or 4-person device sharing software/hardware, sold separately. Collaborative technology requires an HDMI connection between the device and TV. Media sharing can be switched among connected users by the push of a button.



Product #	Product Description	Product Description
Media Tables		
13633280	Media Table Rectangle HPL Back	67" Hx83" Wx55" D Acrylic Sides
13632150	Media Table Rectangle HPL Back	67" Hx69" Wx55" D Acrylic Sides

**Note: 1) Device sharing software/hardware NOT included
2) Monitor NOT included**

Device Sharing Software/Hardware	
13632190	2 Device Connection Technology
13632200	4 Device Connection Technology

NOTE : TECHNOLINK DIMENSIONS IN SPECIFICATION GUIDE REFERS TO DIMENSION BETWEEN STEEL FRAMES

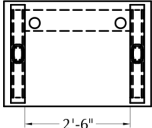
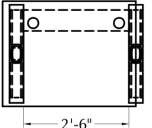
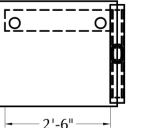
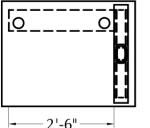
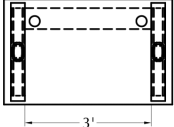
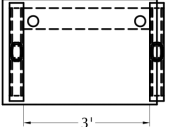
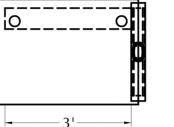
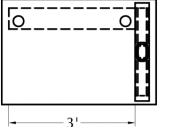
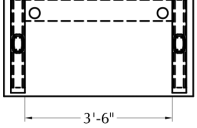
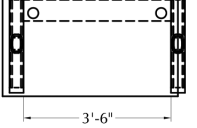
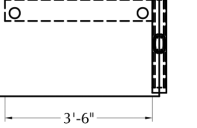
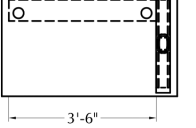
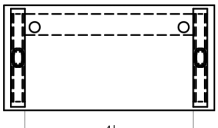
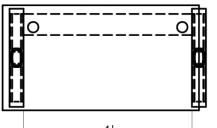
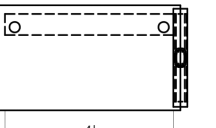
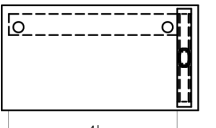
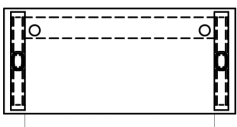
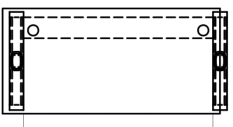
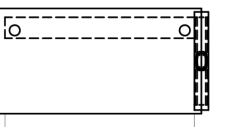
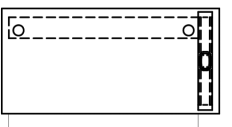
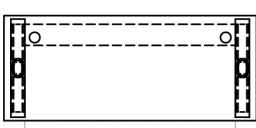
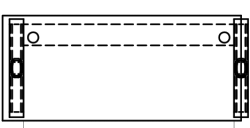
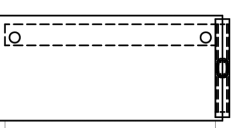
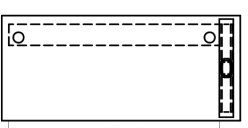
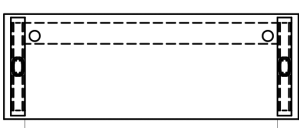
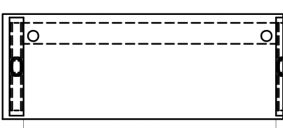
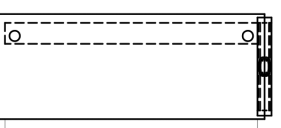
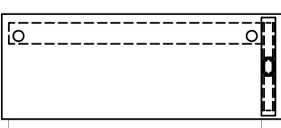
STARTER STAND ALONE	STARTER TO ACCEPT ADDER	ADDER	ADDER END
 2'-6"	 2'-6"	 2'-6"	 2'-6"
 3'	 3'	 3'	 3'
 3'-6"	 3'-6"	 3'-6"	 3'-6"
 4'	 4'	 4'	 4'
 4'-6"	 4'-6"	 4'-6"	 4'-6"
 5'	 5'	 5'	 5'
 6'	 6'	 6'	 6'

<p>45 DEGREE MODULE - STARTER</p>	<p>65" WIDE BULLET TABLE</p>
<p>60 DEGREE MODULE - STARTER</p>	<p>80" WIDE BULLET TABLE</p>
<p>90 DEGREE MODULE - STARTER</p>	<p>49" WIDE BULLET TABLE</p>



4810 Forest Run Road, Madison, WI 53704
ph 800.747.7561 • fax 800.730.8094
email: design@demcointeriors.com • demcointeriors.com